



Update:
12-10-2019

گالری تصویری برخی از تولیدات
شاخه معدن و صنایع معدنی
Photo Gallery- Mining Technology



Vibration Screens

انواع سرندهای لرزشی

مشتریان اصلی:

- شرکت ملی مس ایران
- شرکت مس سونگون: ۸ دستگاه
- شرکت مس سرچشمه: ۶ دستگاه
- معادن گلهر
- شرکت گوهر روش: ۲ دستگاه
- شرکت نظم آوران: ۴ دستگاه
- مس چهل گوره
- ...

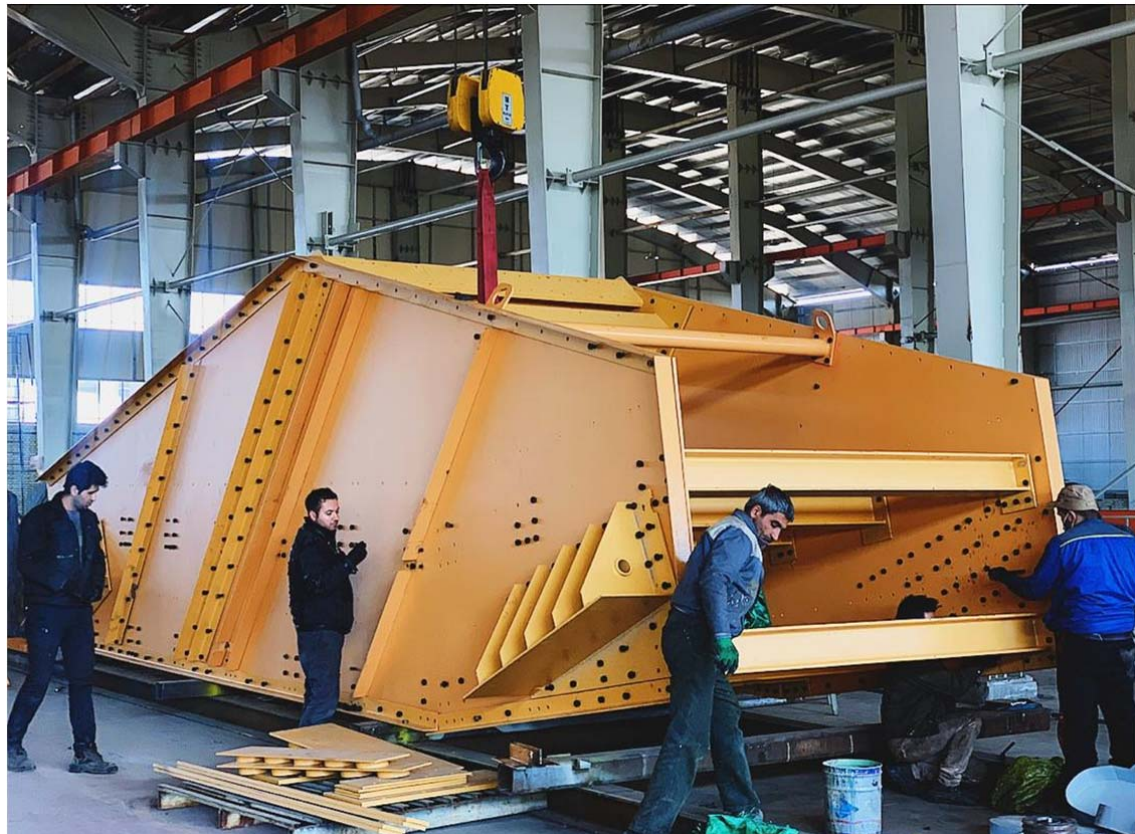









Flotation cells

سلول های فلوتاسیون

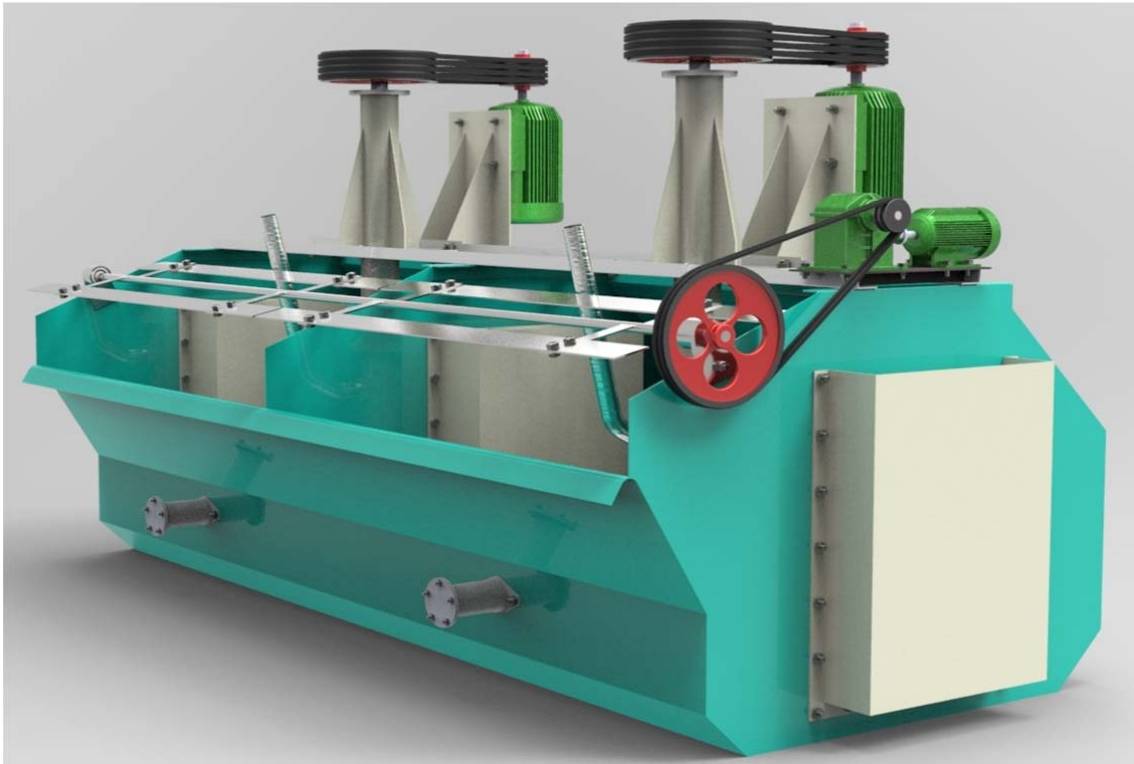

اقلام و لوازم سلول های فلوتاسیون شرکت مس سونگون



Static and Dynamic Samplers

انواع سمپلرهای استاتیکی و دینامیکی

مشتریان اصلی:

- شرکت ملی مس ایران
- خاتم الانبیا - موسسه قرب کربلا
- شرکت مس سونگون:
- شرکت مس سرچشمه:
- معادن گلهر



سمپلر های
استاتیک



سمپلر های
استاتیک



سمپلر
های
استاتیک



ساخت روتاری
سمپلرهای تمام اتو
ماتیک برای اولین بار
در ایران
کارفرما: خاتم الانبیا-
قرب کربلا



Belt and Slab Conveyers

انواع نقاله های اسلب، نواری و ...







تجهیزات شوت و کانوایر پروژه سنگ آهن سنگان خواف به وزن بیش از ۲۰۰ تن



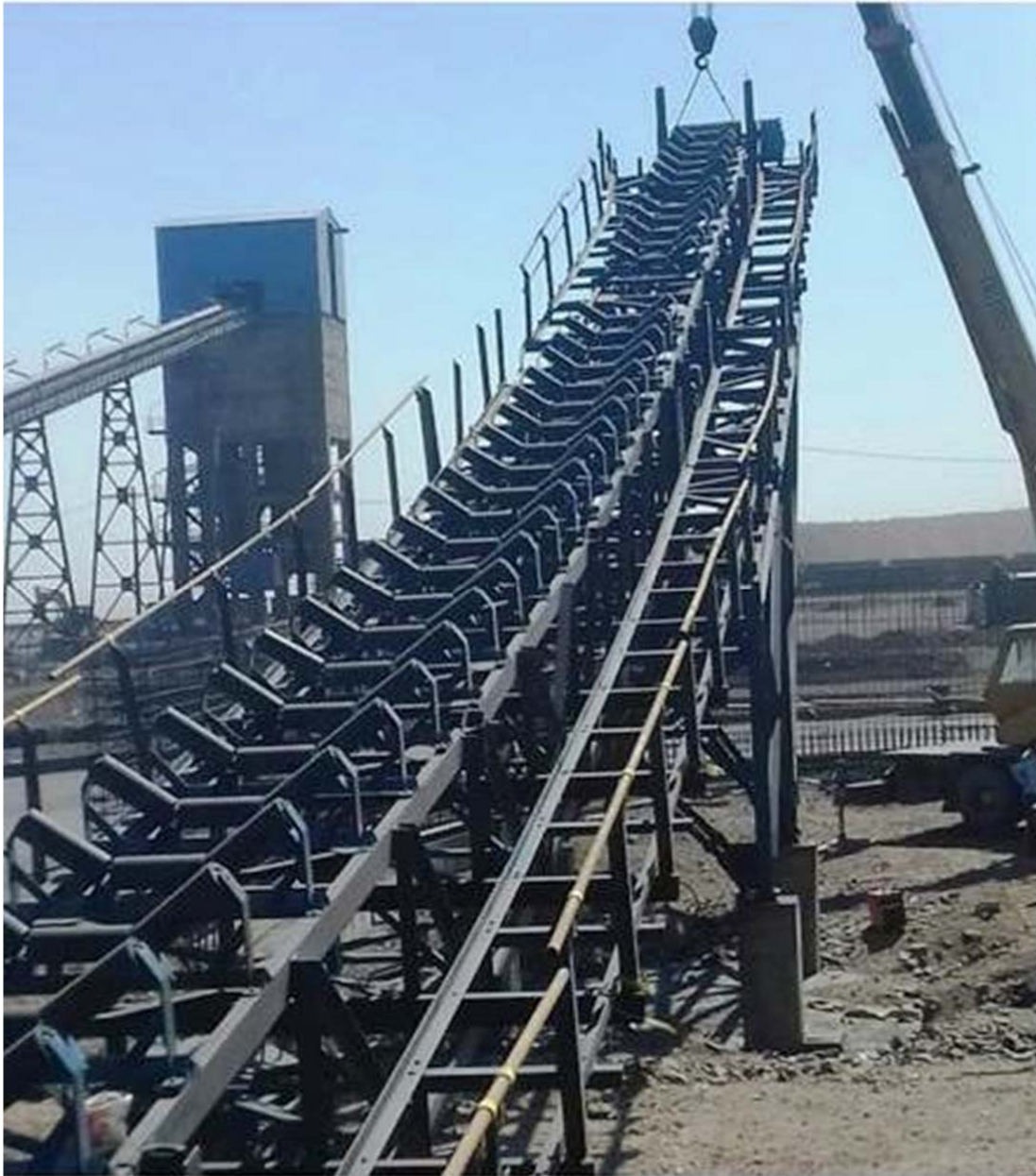



پروژه نوار نقاله های آهک اهر به تعداد ۵ نوار



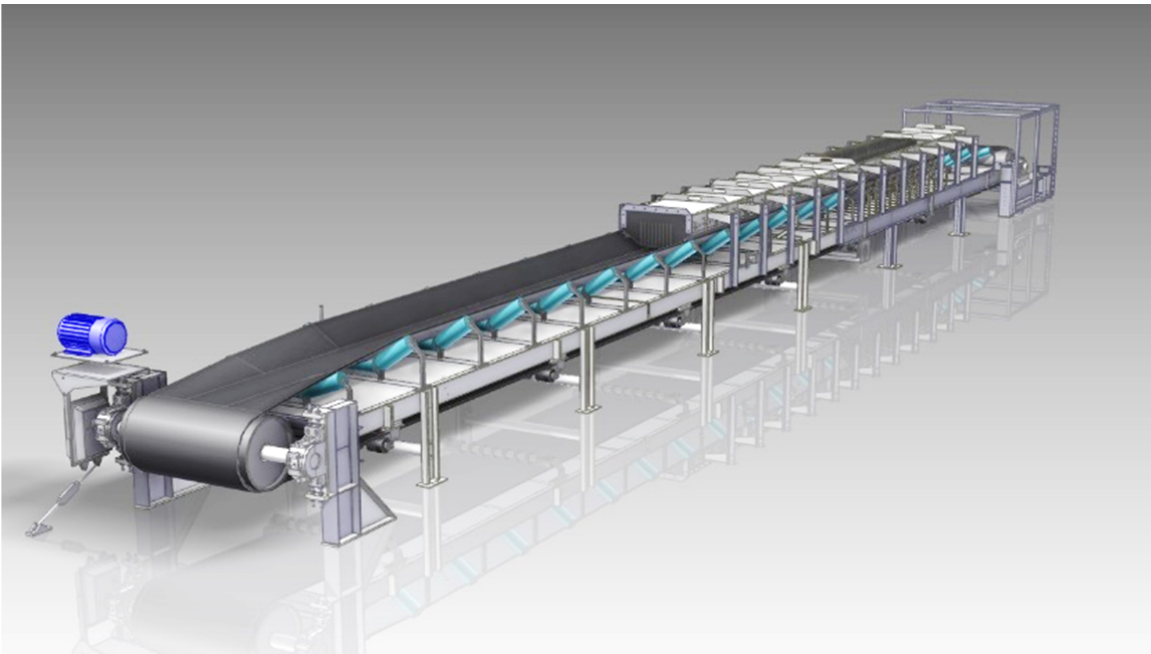
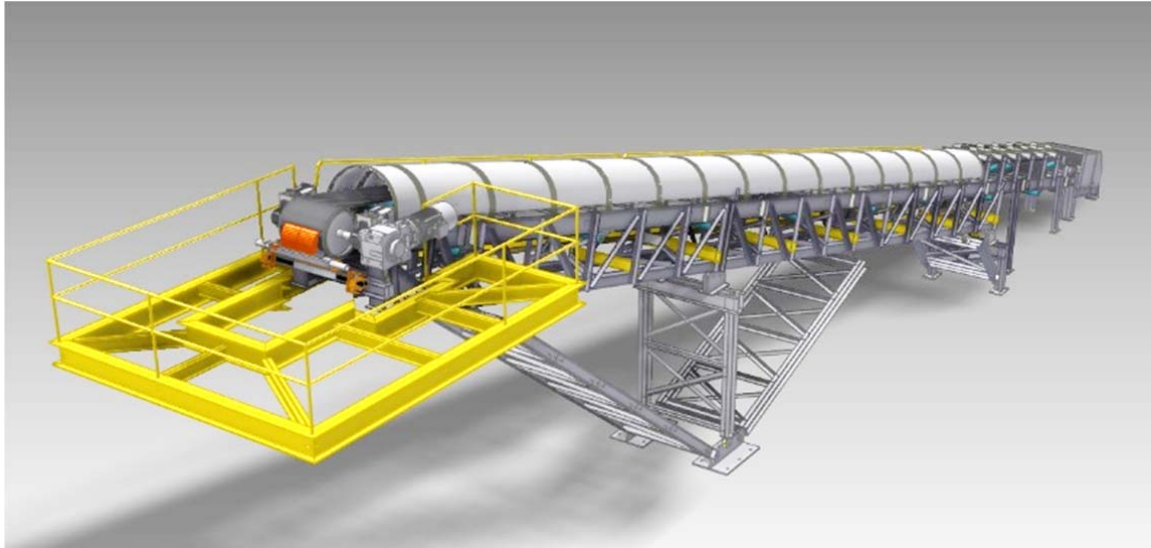



Belt Winder

نوار جمع کن یا بِلِت واینِدر

نصب شده در شرکت مس سونگون

وزن رل بِلِت: ۴۰ تن و قطر ۶ متر





Screw Conveyers

انواع اسکرو کانوایر

کارفرما: شرکت کانی سیب

نصب شده در معدن آهک اهر



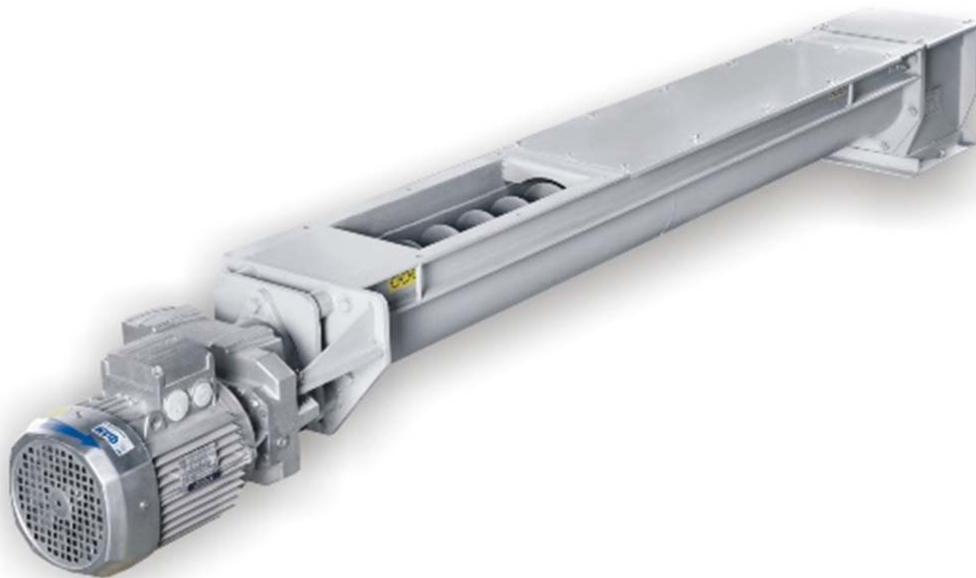
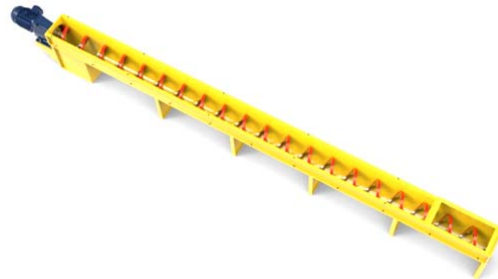



Bucket Elevators

انواع باکت الواتور

کارفرما: شرکت کانی سیب
نصب شده در معدن آهک اهر
نوع: بلتی و زنجری

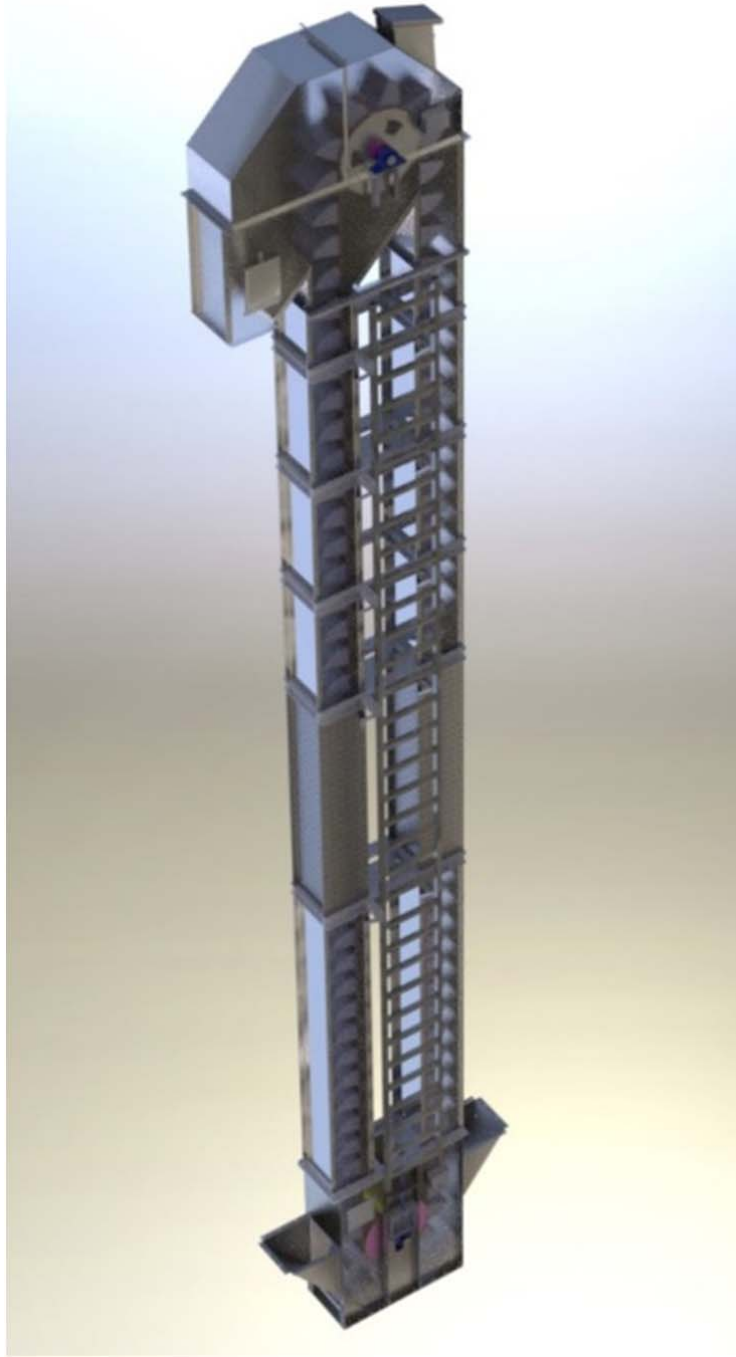

ارتفاع: ۳۵ متر

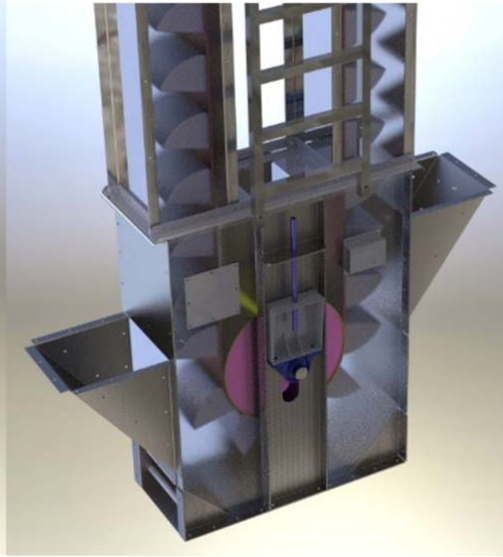
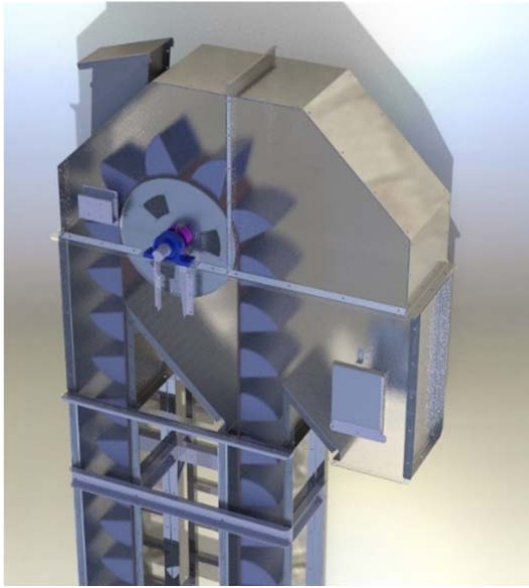



Rolls and Cylinders

انواع غلتک، سیلندر و رولیک

درامهای کانوایر اصلی مس سونگون به وزن بیش از ۲۶ تن جنس استیل







انواع رل و سیلندر با کارد های متنوع در صنایع

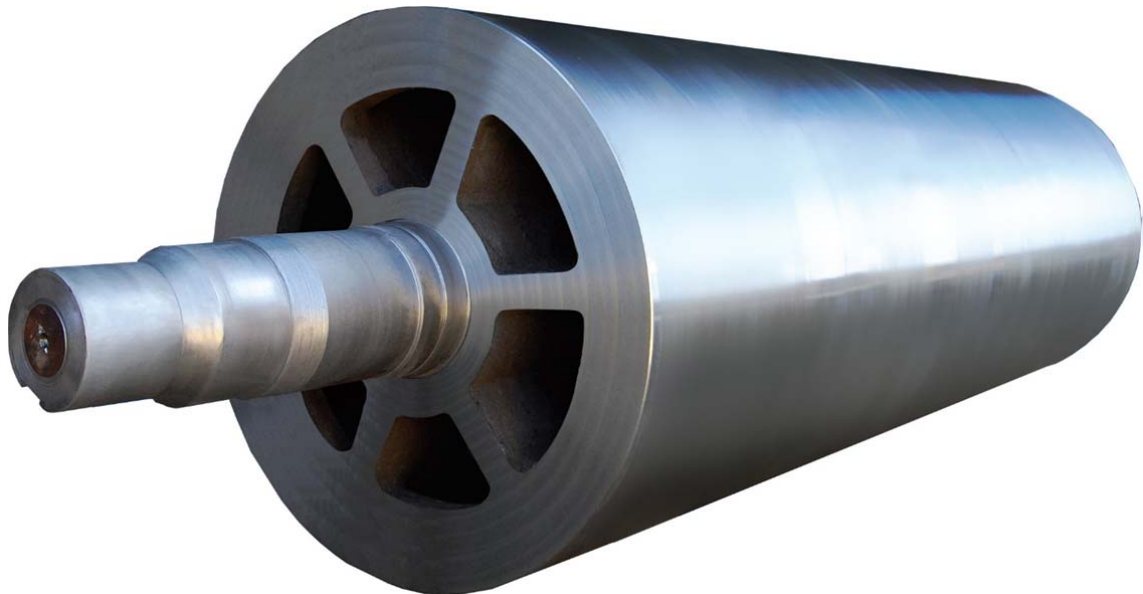

انواع رلیک و غلتک بدون جوش با تکنولوژی شرینگ فیت



انواع رلیک و غلتک های خاص مثل غلتک خم، سیندرهای درایر و ...

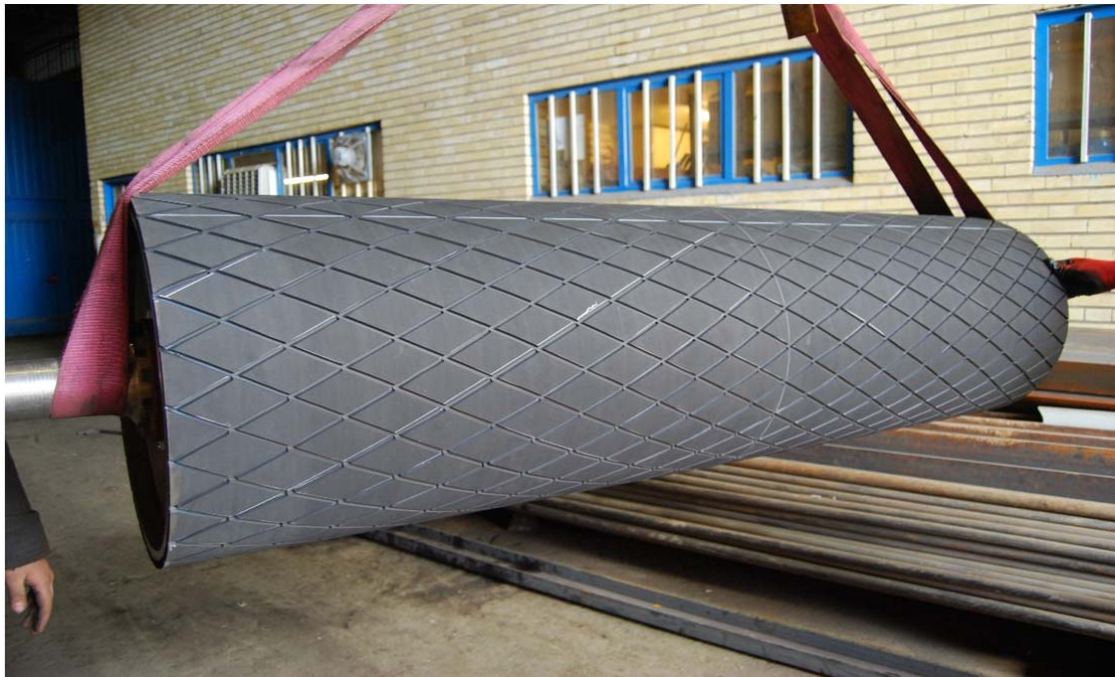



Fixed and Moving Shooting Systems

سیستم های شوتینگ (ثابت و متحرک)



شوت متحرک شرکت مس سونگون



طراحی و ساخت تجهیزات شوت کارخانه تغلیظ مس سونگون - قرارگاه خاتم الانبیا







Chests, Tanks and Reactors

انواع مخازن نگهداری و تحت فشار و راکتورها

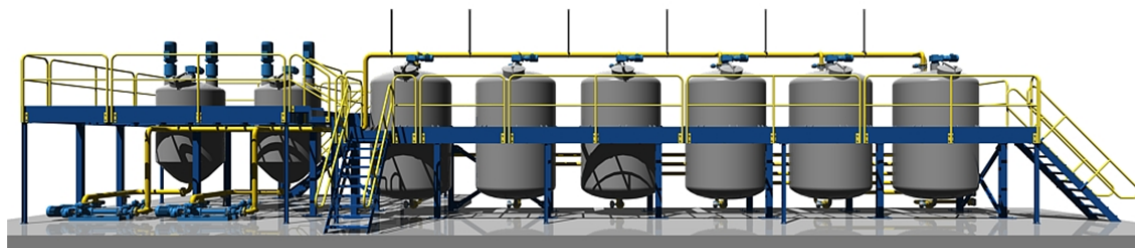
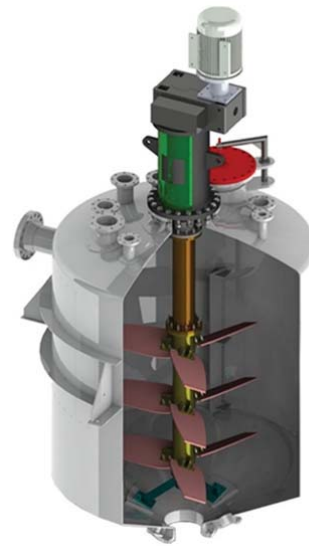
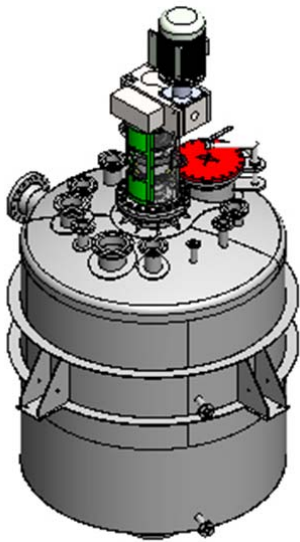





انواع کلاریفایرهای فولادی، استیل و بتنی





انواع سلول های هوادی، شناور سازی برای صنایع مختلف



انواع مخازن و راکتورهای مواد شیمیایی از استیل ضد زنگ



انواع مخازن، میکسرها و آسیاب ها برای صنایع مختلف



**Filtration and Thickening
Equipment**

تجهیزات فیلتراسیون و تغلیظ



تیکنرهای تغلیظ ثقلی

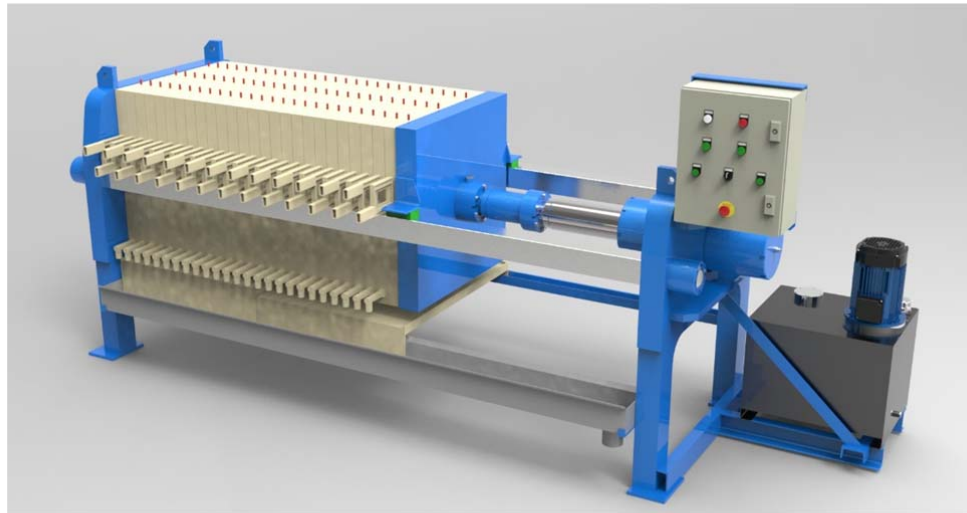



Drum Screens

انواع درام اسکرین و ترومل





تروملهای فاز ۲ شرکت مس سونگون

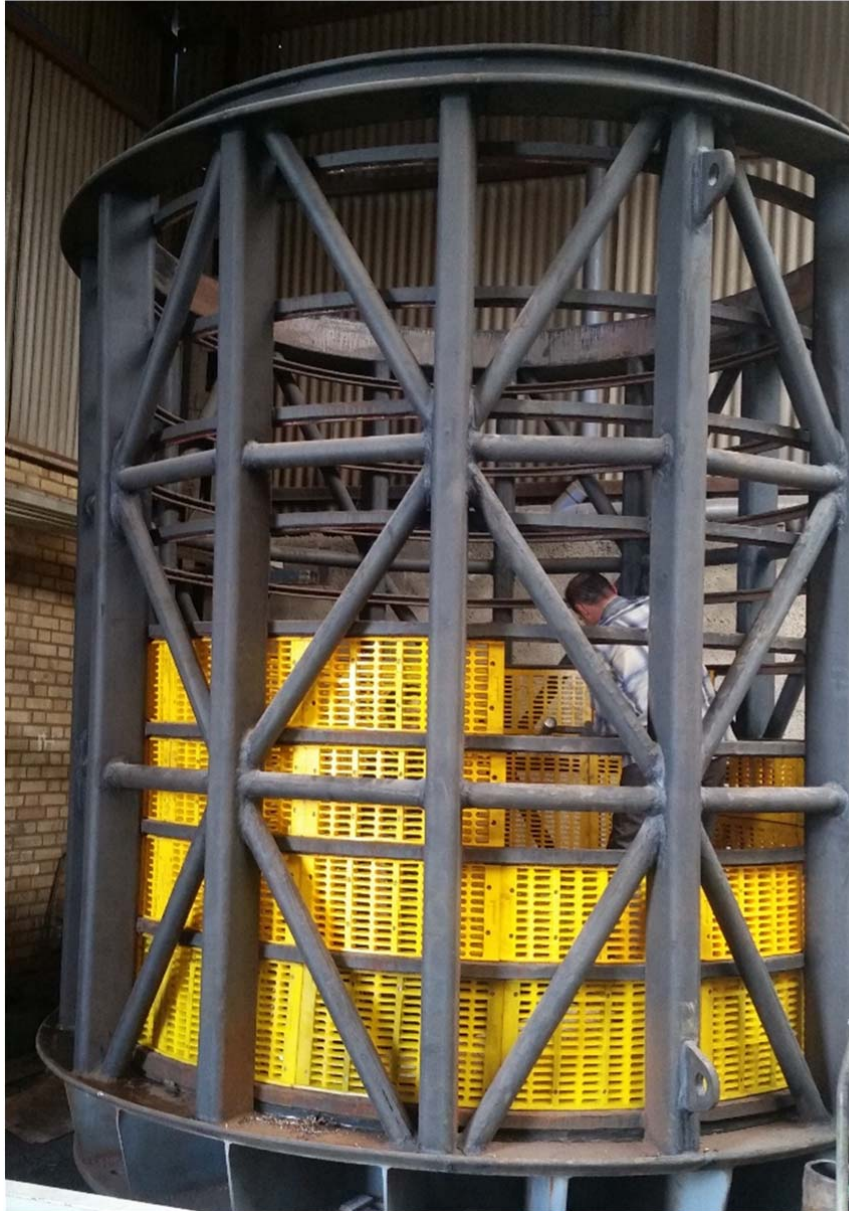



**Sand Separators and Grit
Chambers**

انواع جداکننده سنگ و ماسه





Hydrocyclones

انواع سیکلونها و سپراتورها

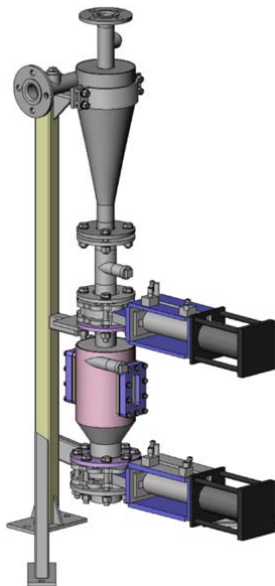
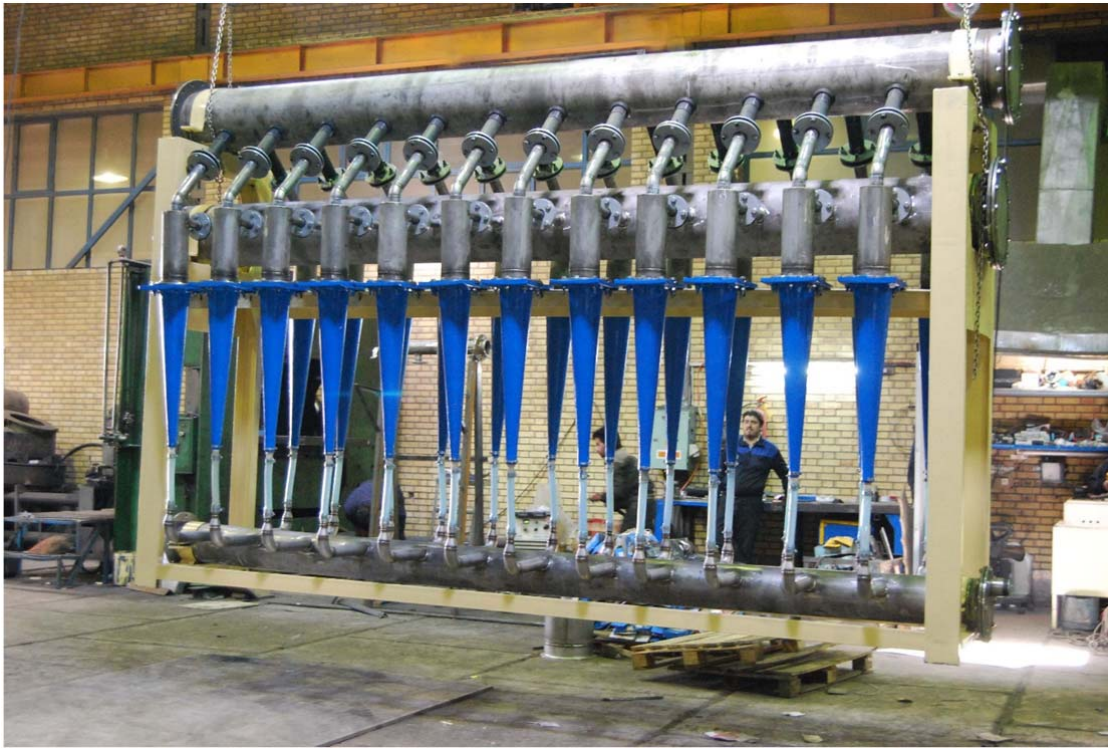

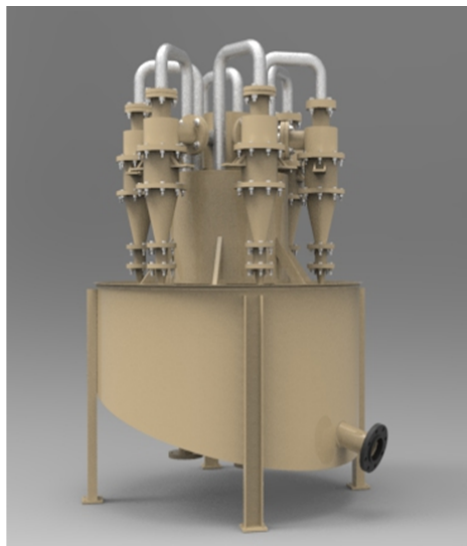



Screw Presses and Screw Feeders

انواع اسکرو پرس و اسکرو فیدر



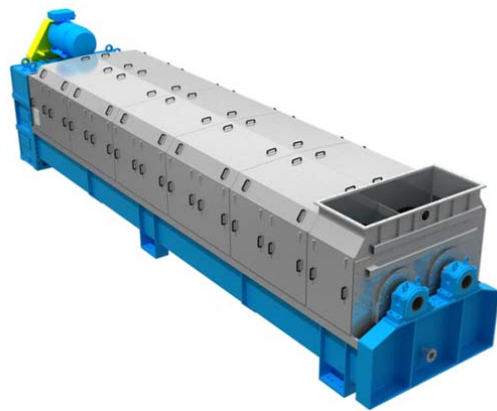



Horizontal and Vertical Mixers and Gitators

انواع همزن ها و میکسرهای افقی و عمودی

همزن حوضچه های خمیر شرکت کاغذ سازی مراغه

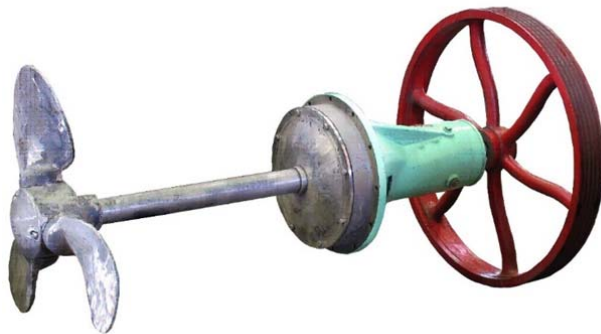

همزن حوضچه های خمیر شرکت کاغذ اترک
برای حوضچه های ۱۰۰۰ متر مکعبی

همزن های افقی برای صنایع مختلف

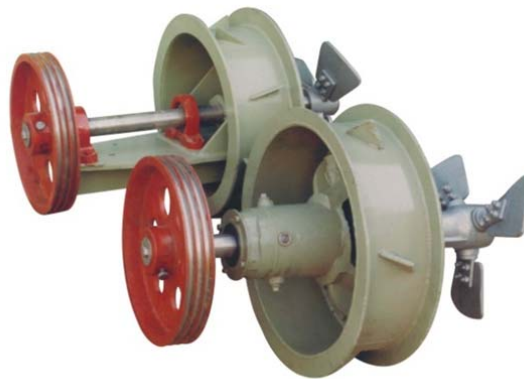



درايو آسیاب های افقی و عمودی

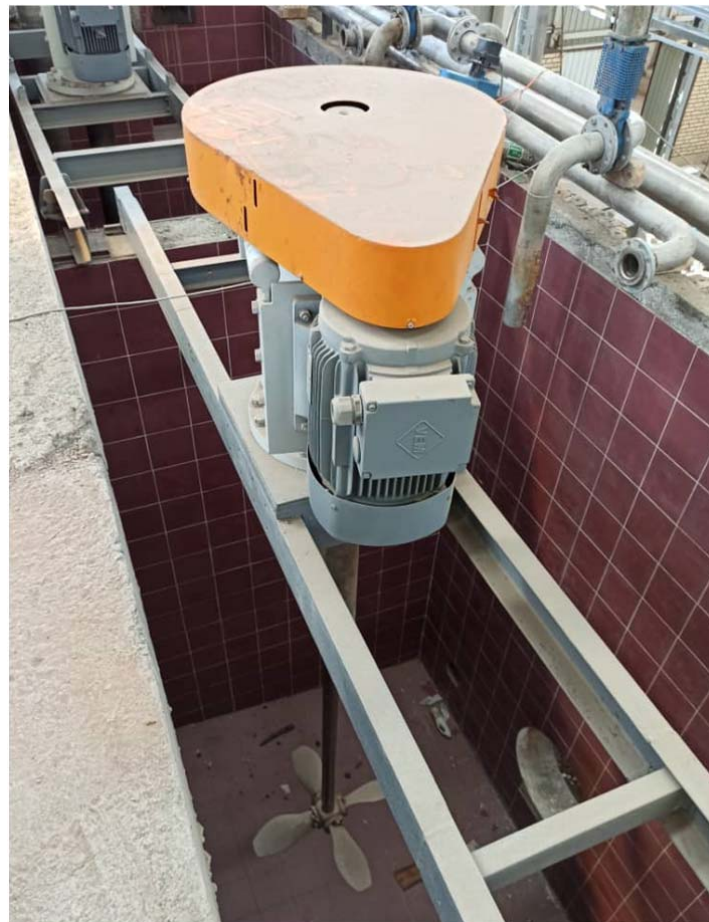



بین های حمل گلوله - مس سونگون





Cranes

جرثقیل های سقف

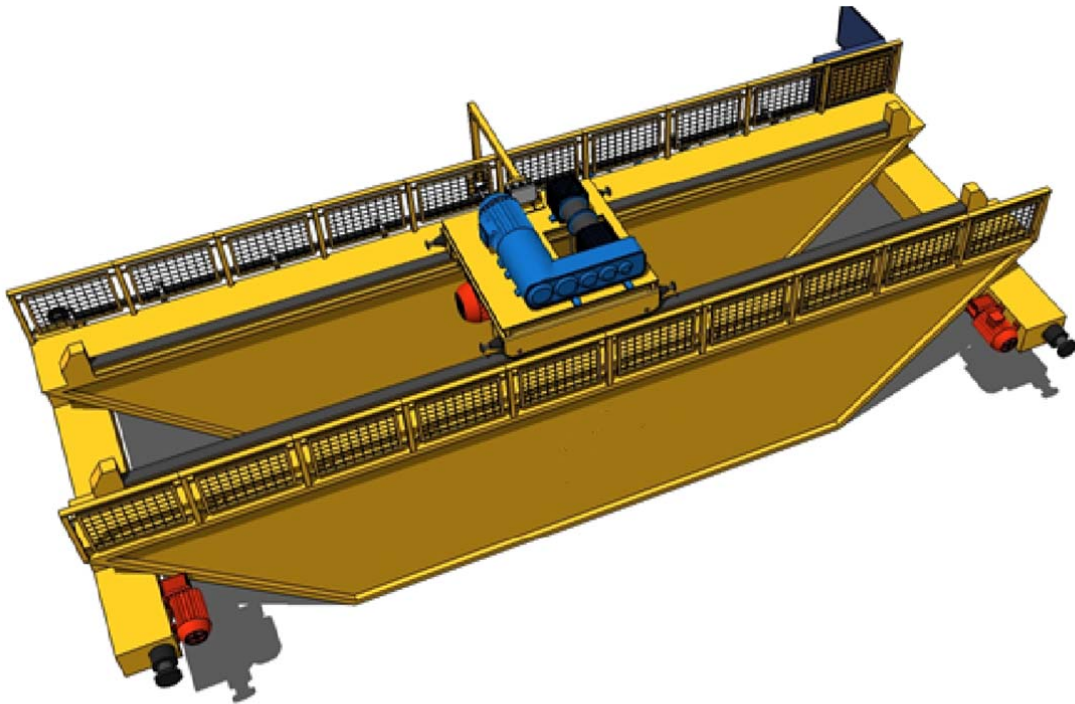
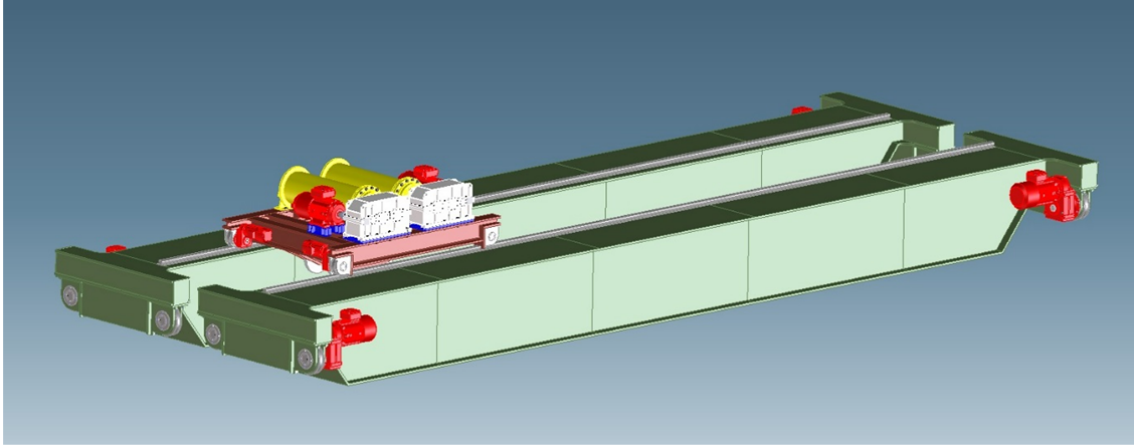



Frames, Structures and sole plates

انواع فریم، شاسی و سول پلیتھا



Custom Design Equipment and Elements

انواع تجهیزات به سفارش و نیاز مشتری











طراحی و ساخت انواع گیربکس های استاندارد و خاص

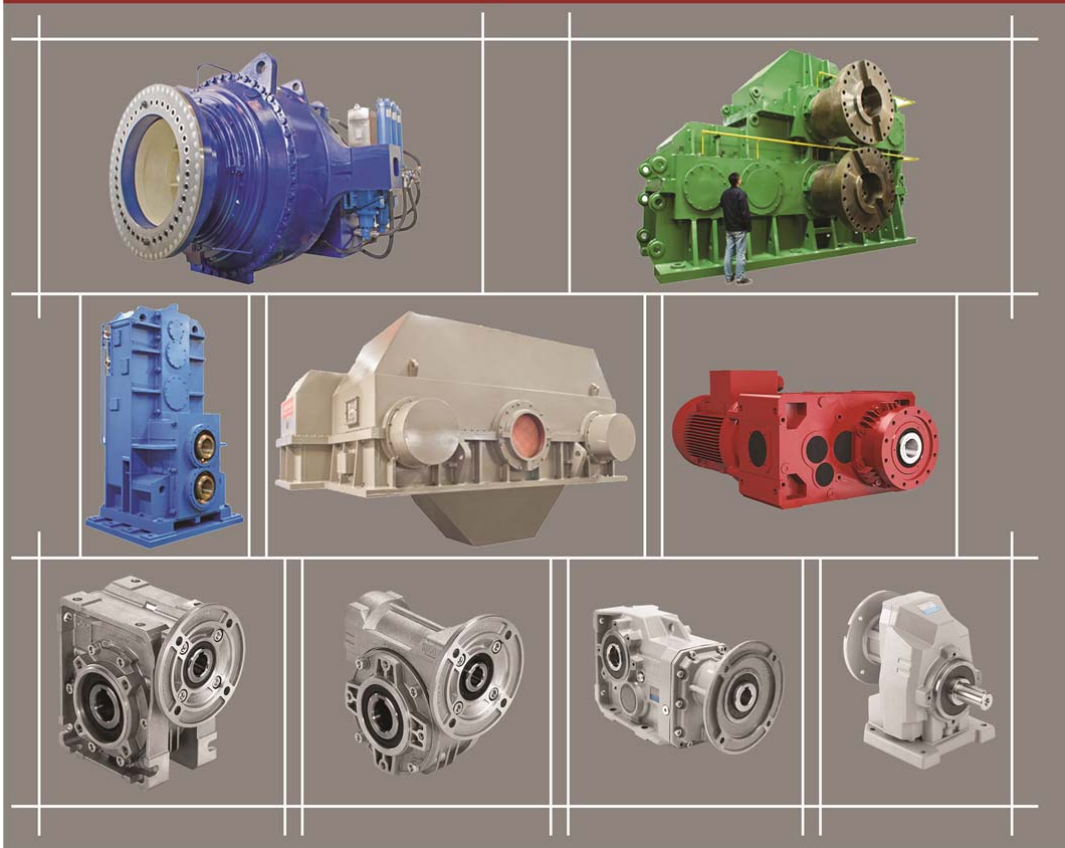



S.P.S. Co. شیمی پژوهش صنعت
SHIMI PAJOUHESH SANAT Co.
ENGINEERING & MACHINERY مهندسی و ماشین سازی

Introduction of
Engineering & Machinery Co.
Shimi Pajouhesh Sanat